



LIVING FAITH

ST. MATTHEW'S LUTHERAN CHURCH

stmatthews@stmatthews.us

www.stmatthews.us

May 2010

FIRST COMMUNION

We recognize the following young people who participated in their first communion on Maundy Thursday.

To mark this day in their faith journey, the congregation presented Bibles with the children's names and date of their first communion inscribed in them. It is hoped that the Bibles will accompany them in Sunday Church School, Confirmation classes and throughout their growth in faith.



- Brian Michael Bennett**
- Lea Elizabeth Brady**
- Gillian Wise Clark**
- Kaitlyn Rose Graham**
- Allyson Joan Hinkofer**
- Tyler Grace Humphreys**
- Carl Joseph Kline**
- Brett Wayne Lembke**
- Brynn Ann Lembke**
- Brandt Evan Nethercutt**
- Greer Elisabeth Riedl**
- Marisa Claire Rigot**
- Caroline Elizabeth Skelley**

"While they were eating, Jesus took a loaf of bread, and after blessing it he broke it, gave it to the disciples and said, 'Take, eat; this is my body.' Then he took the cup, and after giving thanks he gave it to them, saying, 'Drink from It, all of you; for this is my blood of the covenant, which is poured out for many for the forgiveness of sins.'" Matthew 26:26-28.

First communicants participated in foot washing, as Jesus washed the feet of his disciples. "For I have given you an example, that you also should do as I have done to you." John 15:15

Spring Fling Senior Citizen's Luncheon

The next Senior Citizen's Luncheon is Saturday, May 15 starting at noon. See the poster on the Bulletin Board in the narthex to sign up to provide food, transportation, help serve and chat with our guests. This is an opportunity for families to work together in service to others in our community.



Relay for Life

The Young Adults have come together to form a Relay for Life team. In a nutshell, Relay is a self-contained team walk-a-thon to raise funds for the American Cancer Society. It will take place for 24 hours from noon June 5th through noon June 6th at the Prince William County Fairgrounds. We will have a tent or two and a walker on the track constantly, even at 3 am. We have a modest goal of raising \$1,500 for this cause. One of the ways we will be raising money is by selling Luminaria after church services. Luminaria are luminaries that can be dedicated to the memory of someone who has won or lost their battle with cancer and are lit during the event.

We also have a Relay team webpage, http://main.acevents.org/site/TR?pg=team&fr_id=24951&team_id=681156. From there you can donate to any of us individually, our team as a whole, buy a luminaria, or just check in to see how we are doing. Everyone is also welcome to come to the event on June 5th and be a part of all the activities, which include Opening Ceremonies, a Survivors' Walk, music, and games, until 11 pm when the event closes for the evening to the general public. If you have any questions please contact Vicar Johns or Karen Moler, co-captains of our team. Thank you for your support!

NEWSLETTER

MAY BIRTHDAYS & ANNIVERSARIES

2-Kevin MacFarlane
Nancy Zimmerman
3-Hal Deadman
Eileen Eckhardt
Sharen Moessner
5-Sarah Colbert
6-Lisa Bushmire
Mark Victorson
David Strand
Kyler Rosario
7-Bill McCormack
Chuck Moler
8-Charlene Laird
10-Karen Miller
Eric Reifsnyder
11-Cassidy Minihan
Moira Skelley
Bill Brady
12-Diane Wilcox
Joshua Dillon
Ben Amha
13-David Bohannon
14-Tyler Bratton

Sean Lambert
George Gianakaris
Everett Johnson
15-Bill Langman
Tony Occhiuzzo
16-Dorothy Lerch
17-Michael Heimbach
Leslie Brady
Ashlyn Brady
19-William Davis
Cole Lambert
20-Kyle Miller
Jake Woessner
Jim Lee
21-Eileen Goldschmidt
Caroline Strand
Alina Weldon
23-Kris Kuhn
Julie Evans
Shannon Collins
Christopher Wiprud
Jennifer Knick
Amy Stohs

24-Bill Huntington
Daniel Scronce
Robert Beck
Michaela Carlson
Thomas Bortner
Julian Kiedrowski
25-Katie McDaniel
James Miller
27-Cheryl Gordon
Martin Mendoza
Meg Hill
Linda Graham
28-Charlie Phillips
Mark Chandler
29-Merilyn Davis
30-Bruce Anderson
Al Smith
31-Bruce Taylor
Kevin Hoppe

ANNIVERSARIES

3-Bob & Eileen Goldschmidt
Curtis & Dorothy Cochrane
10-Jim & Margarete Miller
11-Doug & Corinne Doerr
14-Gloria & Tom Bortner
Wendy & Darrell Morton
19-Ralph & Patti Scronce

20-David & Christine Martin
27-Jason & Tamera Lerch
28-Rob & Jan Mouw
29-Dave & Barb Carr
31-Evelyn & Bill Langman



Are we missing your birthday or anniversary? If you should be listed under the birthdays or anniversaries and aren't, please call the church office so our records can be updated. We apologize for omitting you!

Summer Music "Table for Five . . . Thousand!"



When Jesus looked up and saw a great crowd coming toward him, he said to Phillip. "Where shall we buy bread for these people to eat?" Phillip answered him.

"Eight months wages would not buy enough bread for each one to have a bite!"

Another of his disciples, Andrew, Simon Peter's brother spoke up. "Here is a boy with five small barley loaves and two small fish, but how far with they go among so many?"

John 6:5-9

This summer's musical highlights several themes:

-  No matter how young or insignificant you feel, God can use you to do great things.
-  Jesus is the bread of life.
-  Jesus cares about a hungry world.

This musical will be presented at both services on July 18th. The music camp meets on Monday, July 5th through Friday, July 16th from 9:00 – 12:00 p.m.

Registration is open to children in the congregation who have completed Kindergarten through High School.

Activities include daily Bible study, prayer, singing, dance and choreography and learning about stage productions.

Participants will decorate a T-shirt (provided) to be used as part of their costume.

****Parent volunteers play an essential role in the camp.**

Attendance at both services is required to participate in the camp.

**** Please register your child by June 1st to guarantee their enrollment and allow for adequate planning time.**

Registration forms are available on the information table in the narthex and on the website.

**Don't forget
Mother's Day
Sunday, May 9**

Mother's Day

NEWSLETTER

Cherub, Youth and Teen Choirs present Joseph and the Amazing Technicolor Dreamcoat on May 9th at both services.

We are presenting the original score written by Andrew Lloyd Weber for a boys chorus. It was received so well that he expanded it and produced it on Broadway.

This musical tells the story of Joseph and his brothers and how God provided for Joseph's care.

It is sung in a variety of musical styles. Some are serious, some light-hearted and some spoofs! It makes for a rollicking musical presentation.

Please show your support for our youth by listening to this important "sermon".



Mark Your Calendars for these events:

Confirmation, Sunday, May 23 at the 11:00 a.m. service. Reception follows. Look for a sign up poster.

Sr. High Graduate Recognition, Sunday, June 6

Last day of Sunday Church School, June 13

SUMMER SCHEDULE begins Sunday, June 20, 8:30 & 10:00 a.m. worship services

PARISH PICNIC -Sunday, June 20 following the 10:00 a.m. service.

VOLUNTEER OPPORTUNITIES

Volunteer at the **ACTS Thrift Store Tuesdays, May 4 and June 1, from noon to 2:00 p.m.** Sort donations, stock and straighten shelves while store personnel and other volunteers break for lunch.

Collators meet in the church narthex at 10:00 a.m. on **Fridays, May 21 and June 18.**

Daytime Drivers: Provide transportation for area senior citizens. Drive to doctors' appointments and other essential services in Eastern Prince William County. Children welcome. Flexible hours. Call 703-491-2898 for more information or to volunteer.

NEWSLETTER



CHURCH WOMEN NEWS

Metro DC W/ELCA May 1st Convention at St. Mark's, Springfield, from 8:00- 4:00. The theme is "Walk Humbly with Your God" from Micah 6:8. Keynote speaker will be Bishop Graham, and there will be Holy Communion, several workshops, and exhibits. The \$25.00 registration fee includes lunch. Contact Susan Kuhn for more information. People may call me for more information.

Join us Tuesday, July 13, 7:30 p.m. as Melanie Laster leads us in an Ombre Tie Dyeing Activity. Ombré, rhymes with the Spanish word hombre, but is actually a French word meaning "shade" or "shadow". (Ombre without the fancy "é" is a very old card game!) For the last couple years, Ombré dyed fashions are appearing everywhere from magazines and fashion designer runways to the racks of discount department stores.

Ombré, also known as dip dyeing, color bleeding, or gradated dyeing, is an effect usually achieved by hand dipping fabric in dye so that it gradually goes from light to dark. We will be tie dyeing scarves. Watch the bulletin board for a sign up poster to indicate your participation and with more details. The deadline to sign up is June 1 so supplies can be ordered.

Summer Field Trip Watch the bulletin board and future newsletters for information about the Women's Summer Field Trip.



**SENIOR HIGH YOUTH
CARWASH
SATURDAY, MAY 22
STARTING AT 10:30 AM**

Come support our youth as they prepare for their trip to Lynchburg to support Habitat for Humanity.

VCS

BAOBAB BLAST

"From East to west, the powerful Lord God has been calling together everyone on earth."

Psalm 50:1

BIBLE STORIES,
MISSION MOMENTS,
SAVANAH STORYTELLING,
KALAHARI CRAFTS,
GRASSLAND GAMES, SERENGETI SCIENCE,
MADAGASCAR MUSIC,
BAOBAB SNACK BITES

July 26 through 30.
9:00 a.m. to noon daily.

Structured program
for children born by December 31, 2006,
through those who've completed 9th Grade.
Nursery for volunteer staff.

Registration Form included in this newsletter.

Contact Susan Kuhn with any questions

Love Heart Sandwiches

Supplies: Heart-shaped cookie cutter, bread, strawberry cream cheese.

Instructions: Remember to wash your hands. Set out cups and napkins. Show a child how to make a heart-shaped sandwich filled with strawberry cream cheese. Cut shapes in the bread and spread with the cream cheese. Ask a child to remember the word *LOVE*. What is a symbol of love? What color reminds us of love?

Pray grace and say, "Love never fails!" before taking the first bite.

"Come Along" Game

This game is about sharing an invitation to be part of the community. Make a circle and choose someone to be "IT". Everyone puts right hands towards the center of the circle. "IT" will move around the inside of the circle and take someone by the hand and say, "Come along." That person will grab the hand of someone else and say, "Come along." The line will continue to grow until "IT" calls out, "Go home." Then everyone will run to get a place in the circle. The person who is left over becomes "It", and the game continues.

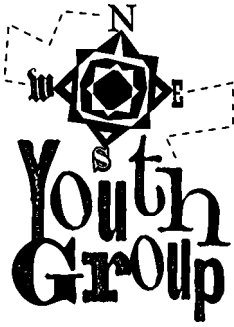

SENIOR HIGH YOUTH

Mark your calendars for the following activities:

Sunday, May 2 – Meeting 6:30-8:30 p.m.

Sunday, May 16– Confirmation Banquet, 6 p.m.

Saturday, May 22 – Car Wash

Sunday, May 23 – Night Vision Lab at Quantico. Leave St. Matthew's 2 p.m.

Sunday, June 20 – Friday, June 25 Habitat for Humanity. Leave Sunday, 5 p.m.

Watch for more information in the bulletin and on the bulletin board!

7th & 8th Grade Youth and Sr High Youth Night Vision Lab

Sunday, May 23, 2 p.m.

NIGHT VISION LAB is the facility in Quantico where Marines both from US and around the globe come and practice the use of night vision goggles on a specially built Challenge course. Since it needs to be dark for the night like conditions during daylight hours, the course is inside.

We have had the unique opportunity to be able to visit the lab every year because our very own Michael Fink runs the facility. However, since the facility is about to be closed, all youth 7-12 grades are invited to have this special experience.

Wear old jeans, T-shirt and sneakers (or other sturdy closed toe shoes). **ABSOLUTELY NO FLIP FLOPS!** Watch the bulletin board for a sign up poster.

May Confirmation Meals

5	SLOPPY JOES	*1. Pam/Kevin Hoppe 2. Jenni Rigot 3. Kathy Brown
12	HOAGIES	*1. Leslie Kinneberg 2. Charlene Laird 3. Moessner
19	BURGERS	*1. Vince Amato 2. Jennie Rigot 3. Amy Stone 4. Moessner

NEWSLETTER

“Trailers for Sale or Rent Rooms to Let, 50 cents...”

Well, actually it's “Tables” and not for sale or rent. We're replacing the tables at St. Matthew's within the next few weeks and the current tables (in good shape) will be available to members who may want to have a six or eight foot table on hand for special occasions.

If you are interested in a table call the church office and you will be contacted when the tables become available.

TABLE TABLE TABLE

“Ah, just a call to Judy or Sue.

Gets a six or eight foot table for you.

Without no fee or dues.

(first come first served till gone)

A table or two for you.”

Drop In Center Updates

St. Matthew's, through activities sponsored by the Social Ministry Committee, provides support to the Drop-In Center. Below is an update on some of those projects.

Personal Care Kits

The Social Ministry Committee is pleased to report that, due to your generosity and faithfulness, St. Matthew's was able to donate 46 complete Personal Care Kits to the Prince William County Drop in Center. In addition to the completed kits, we donated 2 boxes of personal items, a box of socks and a box of washcloths for the Center to dispense as needed.

Thrivent Grant

Thrivent Financial for Lutherans has graciously given St. Matthew's a \$1000 grant to be used to purchase daily operating supplies for the Drop in Center. We will be purchasing cleaning products, paper products and other daily operating essentials for the Center. Thank You *Thrivent Financial!*

Drop in Center Meal Support

Beginning in April and continuing through October, we will be providing lunches for the Prince William County Drop in Center on the 4th and 5th Fridays of the month. Currently, the Center serves approximately 35-45 clients per day for the noon meal. Look for a sign up sheet posted on the board in the narthex indicating items needed for the meal(s). Please prayerfully consider how you can assist us in this endeavor.

NEWSLETTER

Acolyte & Lector Training

A training session for new acolytes will be held on Sunday, May 2, at 1:30 p.m., followed by a Lector training at 3 p.m. An acolyte must be at least 5'7" (4'9") in height and 4th grade or older.

Adult members, as well as our senior high students who have been confirmed, are invited to attend the Lector training.

Please indicate your interest in attending either training session by signing up on the poster on the narthex bulletin board.

If you have any questions, speak to Nancy Zimmerman

Day School Registration On-Going

Registration for the 2010-2011 Day School Year is continuing. There are still spaces available. If you are interested in enrolling your child, stop by the church office or call and ask to speak to Mary-Catherine Deadman. Children need to be 3 years old by December 31 of this year and potty trained to attend. 2-day, 3-day and 4-day classes are available.

The National Lutheran Home Auxiliary's Spring Festival

Saturday, May 1

9:30 a.m.-2:00 p.m.

9701 Veirs Drive Rockville

Silent Auction, Grandma's Attic, Plants, Jewelry, Resident Crafts, Baked Goods, Candy, Handwork, Books, Postcards, Stamps,

Games, Videos

Gift Shop 50% off Sale

All proceeds benefit the residents

Lunch served 11 a.m.-1:00 p.m.

Independent Cottage Tours

Home Chorus program

2:30 in the Chapel.

For information call 301-424-9560

Music and Art in Worship

God gives many gifts and talents to his people. Some artists and musicians are blessed with creative talents and the desire to use them to the glory of God.

Composers and hymnwriters continually add to the rich treasure of hymns and choral music that form an important part of our worship. Many organ solos and choir anthems are new settings, or arrangements, of hymns. This music enriches our understanding of the meaning and power of the word of God, and gives voice to our praise of God as we come together each Sunday.

God also works through artists who design visually meaningful spaces for worship. Our Easter Sunday worship began the moment when we entered the sanctuary and our spirits were uplifted by the gold and white fabric draping the rafters! To me the fabric was an artistic rendering of "Alleluia! He is risen!" The idea for the rafter fabrics came from Pastor Bohannon; they were created by Evelyn Langman and Molly Parker and placed by Keith Cotner, Dave Lambert and Brandon Johns. Let us give thanks to God for the creative gifts of all artists and musicians who seek to glorify Him through art and music.

Betsy Lord

SOFTBALL SCHEDULE



Come support the St. Matthew's Angels as they prepare for another winning softball season. Games are double headers and are played on the fields outside of the

Potomac Nationals Stadium.

Fri., May 7	8:30 & 9:30 p.m.
Fri., May 14	9:30 a.m.
Sat., May 15	1:30 & 2:30 p.m.
Sat., May 22	1:30 & 2:30 p.m.
Fri., June 4	6:30 & 7:30 p.m.
Sat., June 12	9:00 & 10:00a.m.
Sat., June 26	1:30 p.m.
Fri., July 9	6:30 & 7:30 p.m.
Sat., July 17	11:00 a.m. & noon

NEWSLETTER

May 2010 Calendar

See the Weekly Bulletin Calendar for Updates

Women of the ELCA Convention	Sat., May 1
Extra-Ordinary Sunday Grades 1,2, 3	Sun., May 2, 9:45 a.m.
Acolyte Training	Sun., May 2, 1:30 p.m.
Lector Training	Sun., May 2, 3 p.m.
Sr. High Youth	Sun., May 2, 6:30-8:30 p.m.
Men's Bible Study	Sun., May 2, 7 p.m.
PreSchool Choir	Mon., May 3, 4-4:30 p.m.
Day School Parent Orientation	Mon., May 3, 7:30 p.m.
Volunteers to ACTS	Tues., May 4, 12-2 p.m.
Social Ministry Committee	Tues., May 4, 7:30 p.m.
Women's Bible Study	Weds., May 5, 9:30 – 11 a.m. Childcare provided
Confirmation	Weds., May 5, 5:30-7:30 p.m.
Sr. Choir	Weds., May 5, 8 p.m.
Bible Study	Thurs., May 6, 10-11:30 a.m.
Cherub Choir	Thurs., May 6, 6:15 – 6:45 p.m.
Youth Choir	Thurs., May 6, 7-7:45 p.m.
Teen Choir	Thurs., May 6, 8 – 8:45 p.m.
Finance & Stewardship Committee	Thurs., May 6, 8 p.m.
Synod Assembly	Fri., May 7 – Sat., May 8
PreSchool Choir	Mon., May 10, 4-4:30 p.m.
Property Committee	Tues., May 11, 7:30 p.m.
Women's Bible Study	Weds., May 12, 9:30 – 11 a.m. Childcare provided
Confirmation	Weds., May 12, 5:30 – 7:30 p.m.
Sr. Choir	Weds., May 12, 8 p.n.
Bible Study	Thurs., May 13, 10 – 11:30 a.m.
Staff Meeting	Thurs., May 13, 12:30 p.m.

Cherub Choir	Thurs., May 13, 6:15 – 6:45 p.m.
Youth Choir	Thurs., May 13, 7 – 7:45 p.m.
Teen Choir	Thurs., May 13, 8 – 8:45 p.m.
Evangelism Committee	Thurs., May 13, 8 p.m.
Set up Sr. Citizen Lunch	Fri., May 14, 6 p.m.
Sr. Citizen Lunch	Sat., May 15, noon
Confirmation Banquet	Sun., May 16, 6 p.m.
PreSchool Choir	Mon., May 17, 4 – 4:30 p.m.
Worship & Music Committee	Tue., May 18, 7:30 p.m.
Women's Bible Study	Weds., May 19, 9:30 – 11 a.m. Childcare Provided
Confirmation	Weds., May 19, 5:30 – 7:30 p.m.
Sr. Choir	Weds., May 19, 8 p.m.
Bible Study	Thurs., May 20, 10 – 11:30 a.m.
Prime Timers	Thurs., May 20, 12:30 p.m.
Cherub Choir	Thurs., May 20, 6:15 – 6:45 p.m.
Youth Choir	Thurs., May 20, 7 – 7:45 p.m.
Teen Choir	Thurs., May 20, 8 – 8:45 p.m.
Fellowship Committee	Thurs., May 20, 7 p.m.
Collating	Fri., May 21, 10 a.m.
Set up for Confirmation	Sat., May 22, 9 a.m.
Sr. High Youth Car Wash	Sat., May 22, 10:30 a.m.
Confirmation	Sun., May 23, 11 a.m. service. Reception follows service
Scrapbook Gathering	Sun., May 23, 1-6 p.m.
7 th & 8 th Grade and Sr. High Youth to Night Vision Lab	Sun., May 23, 2 p.m.
Council Meeting	Sun., May 23, 7 p.m.
Women's Steering Committee	Tues., May 25, 7:30 p.m.
Women's Bible Study	Weds., May 26, 9:30 – 11 a.m. Childcare Provided

NEWSLETTER

Sr. Choir	Weds., May 26, 8 p.m.
Bible Study	Thurs., May 27, 10 – 11:30 a.m.
Cherub Choir	Thurs., May 27, 6:15 – 6:45 p.m.
Youth Choir	Thurs., May 27, 7 – 7:45 p.m.
Teen Choir	Thurs., May 27, 8 – 8:45 p.m.
Christian Ed. Committee	Thurs., May 27, 7:30 p.m.

Looking Ahead:

June 13 – Last Day Sunday Church School until Sept. 19

June 20 – Summer Worship Schedule - Services at 8:30 and 10:00 a.m.

June 20 – Parish Picnic following 10:00 a.m. service

Summer Music – July 5 – 16. Musical presented at both services Sun., July 18

Vacation Church School – July 26 – 30



Make this easy snack for your family or your friends at Sunday school. As you eat it, celebrate the miracles God brings in the spring.

What you need:

- 2 cups milk
- 1 (4-serving size) box of chocolate instant pudding
- 1 (8 oz.) tub of frozen whipped topping, thawed
- 1 (16 oz.) package Oreo cookies, crushed
- 8 (9 oz.) plastic cups
- gummy worms and frogs
- plastic flowers (optional)

What you do:

1. Mix milk and pudding in a large bowl. Beat with a whisk until well blended. Let stand 5 minutes.
2. Add whipped topping and half of the crushed Oreos.
3. Place 1 tablespoon crushed Oreos in each cup. Fill cups $\frac{3}{4}$ full with pudding.
4. Top with remaining crushed Oreos.
5. Chill at least 1 hour or until ready to serve.
6. Decorate with gummy worms and/or frogs.
7. Place the stem end of the plastic flower into the center of the pudding dessert.

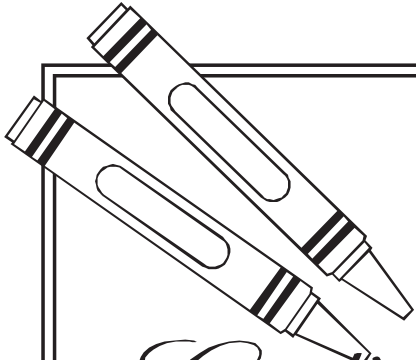

Just for **KIDS**

God's teaching is like....

In Deuteronomy, Moses' words to the children of Israel remind us of spring, which brings growth and new life.

Use the flower code below to fill in the blanks, revealing Deuteronomy 32:2, NIV.



"Let my teaching fall like

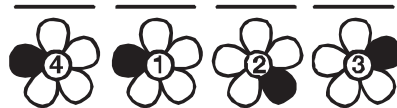

and my words descend like



like

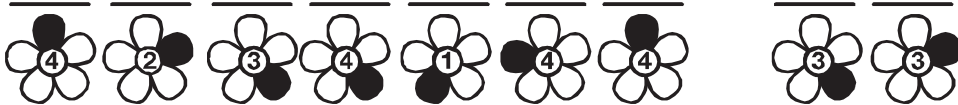

like abundant

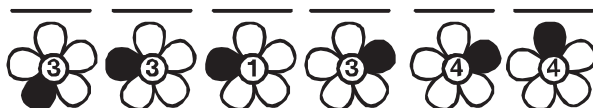
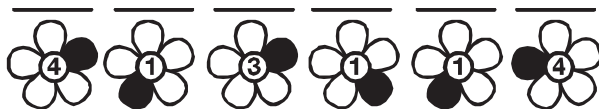

Answers: rain, dew, showers on new grass, rain on tender plants